

Werkzeughalter-System für
Ein- und Mehrspindel-Drehautomaten
Schnellwechselbar und voreinstellbar

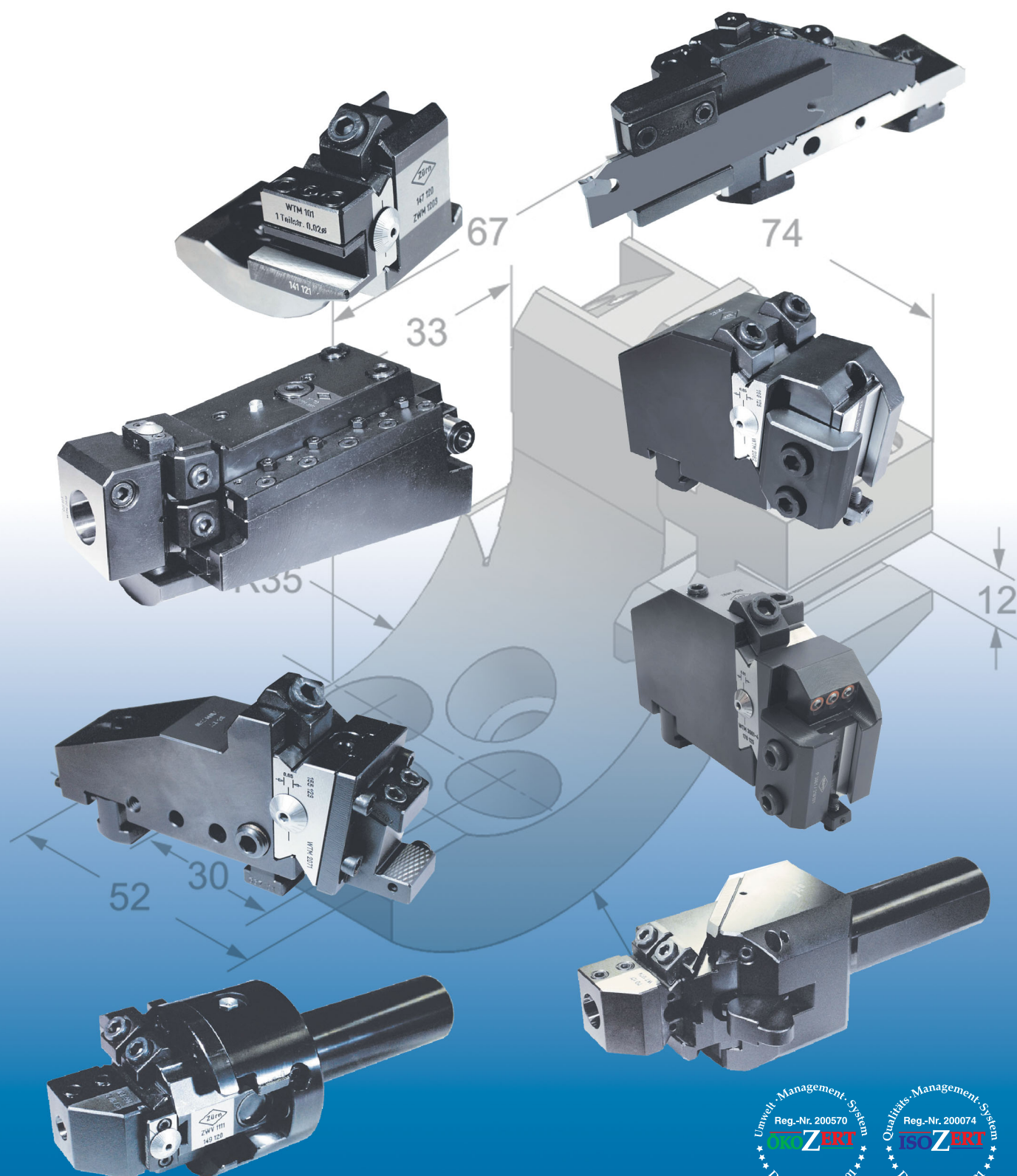

Katalog Nr. 159
Catalogue No. 159

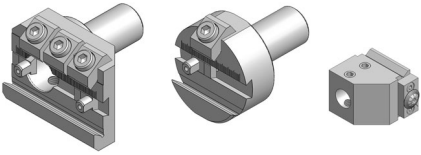
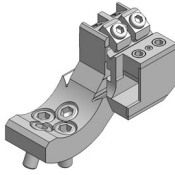
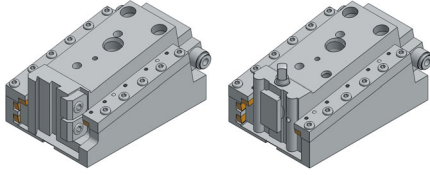
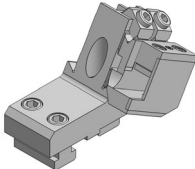
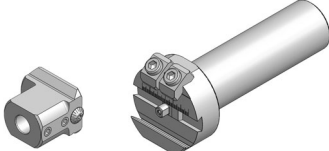
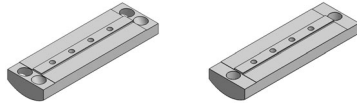
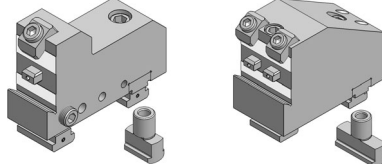
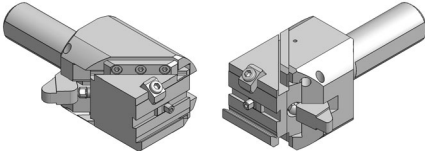
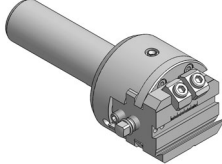

<p>Grundwerkzeughalter und Werkzeugträger mit zylindrischer Aufnahme</p> 	<p>Grundwerkzeughalter und Werkzeugträger zum Längsdrehen für Schütze</p> 	<p>Schwere Einstechschieber für Schütze</p> 																																																																												
<table border="1"> <thead> <tr> <th>Art.-Nr.</th> <th>Typ</th> </tr> </thead> <tbody> <tr><td>104120</td><td>ZW 1105 ø25,00</td></tr> <tr><td>105120</td><td>ZW 1106 ø25,40</td></tr> <tr><td>106120</td><td>ZW 1107 ø31,75</td></tr> <tr><td>107120</td><td>ZW 1110 ø25,00</td></tr> <tr><td>108120</td><td>ZW 1111 ø25,40</td></tr> <tr><td>111120</td><td>ZW 1112 ø30,00</td></tr> <tr><td>109120</td><td>ZW 1113 ø31,75</td></tr> <tr><td>110120</td><td>ZW 1114 ø40,00</td></tr> <tr><td colspan="2"> </td></tr> <tr><td>101121</td><td>WT 1061</td></tr> <tr><td>102121</td><td>WT 1062</td></tr> <tr><td>103121</td><td>WT 1063</td></tr> <tr><td>104121</td><td>WT 1064</td></tr> <tr><td>105121</td><td>WT 1065</td></tr> <tr><td>106121</td><td>WT 1070 ø 8</td></tr> <tr><td>107121</td><td>WT 1071 ø10</td></tr> <tr><td>108121</td><td>WT 1072 ø12</td></tr> <tr><td>109121</td><td>WT 1073 ø16</td></tr> <tr><td>110121</td><td>WT 1074 ø20</td></tr> <tr><td>111121</td><td>WT 1075 ø25</td></tr> <tr><td>112121</td><td>WT 1076 ø18</td></tr> </tbody> </table>	Art.-Nr.	Typ	104120	ZW 1105 ø25,00	105120	ZW 1106 ø25,40	106120	ZW 1107 ø31,75	107120	ZW 1110 ø25,00	108120	ZW 1111 ø25,40	111120	ZW 1112 ø30,00	109120	ZW 1113 ø31,75	110120	ZW 1114 ø40,00			101121	WT 1061	102121	WT 1062	103121	WT 1063	104121	WT 1064	105121	WT 1065	106121	WT 1070 ø 8	107121	WT 1071 ø10	108121	WT 1072 ø12	109121	WT 1073 ø16	110121	WT 1074 ø20	111121	WT 1075 ø25	112121	WT 1076 ø18	<table border="1"> <thead> <tr> <th>Art.-Nr.</th> <th>Typ</th> </tr> </thead> <tbody> <tr><td>145120</td><td>ZWM 1201</td></tr> <tr><td>146120</td><td>ZWM 1202</td></tr> <tr><td>147120</td><td>ZWM 1203</td></tr> <tr><td>150122</td><td>ZWM 2203</td></tr> <tr><td>151122</td><td>ZWM 2204/05</td></tr> <tr><td colspan="2"> </td></tr> <tr><td>141121</td><td>WTM 1001</td></tr> <tr><td>141123</td><td>WTM 2201</td></tr> <tr><td>142123</td><td>WTM 2202</td></tr> <tr><td>143123</td><td>WTM 2203</td></tr> </tbody> </table>	Art.-Nr.	Typ	145120	ZWM 1201	146120	ZWM 1202	147120	ZWM 1203	150122	ZWM 2203	151122	ZWM 2204/05			141121	WTM 1001	141123	WTM 2201	142123	WTM 2202	143123	WTM 2203	<table border="1"> <thead> <tr> <th>Art.-Nr.</th> <th>Typ</th> </tr> </thead> <tbody> <tr><td>207122</td><td>ZWME 2220</td></tr> <tr><td>221128</td><td>ZWME 2221</td></tr> </tbody> </table>	Art.-Nr.	Typ	207122	ZWME 2220	221128	ZWME 2221				
Art.-Nr.	Typ																																																																													
104120	ZW 1105 ø25,00																																																																													
105120	ZW 1106 ø25,40																																																																													
106120	ZW 1107 ø31,75																																																																													
107120	ZW 1110 ø25,00																																																																													
108120	ZW 1111 ø25,40																																																																													
111120	ZW 1112 ø30,00																																																																													
109120	ZW 1113 ø31,75																																																																													
110120	ZW 1114 ø40,00																																																																													
101121	WT 1061																																																																													
102121	WT 1062																																																																													
103121	WT 1063																																																																													
104121	WT 1064																																																																													
105121	WT 1065																																																																													
106121	WT 1070 ø 8																																																																													
107121	WT 1071 ø10																																																																													
108121	WT 1072 ø12																																																																													
109121	WT 1073 ø16																																																																													
110121	WT 1074 ø20																																																																													
111121	WT 1075 ø25																																																																													
112121	WT 1076 ø18																																																																													
Art.-Nr.	Typ																																																																													
145120	ZWM 1201																																																																													
146120	ZWM 1202																																																																													
147120	ZWM 1203																																																																													
150122	ZWM 2203																																																																													
151122	ZWM 2204/05																																																																													
141121	WTM 1001																																																																													
141123	WTM 2201																																																																													
142123	WTM 2202																																																																													
143123	WTM 2203																																																																													
Art.-Nr.	Typ																																																																													
207122	ZWME 2220																																																																													
221128	ZWME 2221																																																																													
<p>Grundwerkzeughalter und Werkzeugträger zum Längsdrehen für Gildemeister + Pittler</p> 	<p>Grundwerkzeughalter und Werkzeugträger für Innenbearbeitung</p> 	<p>Unterbauleisten für schwere Einstechschieber für Schütze</p>  <table border="1"> <thead> <tr> <th>Art.-Nr.</th> <th>Typ</th> </tr> </thead> <tbody> <tr><td>208122</td><td>SD 32</td></tr> <tr><td>209122</td><td>SD 50</td></tr> <tr><td>210122</td><td>SD 63+80</td></tr> <tr><td>211122</td><td>SF 32-51</td></tr> <tr><td>212122</td><td>SF 63-81</td></tr> <tr><td>198122</td><td>AF 67</td></tr> </tbody> </table>	Art.-Nr.	Typ	208122	SD 32	209122	SD 50	210122	SD 63+80	211122	SF 32-51	212122	SF 63-81	198122	AF 67																																																														
Art.-Nr.	Typ																																																																													
208122	SD 32																																																																													
209122	SD 50																																																																													
210122	SD 63+80																																																																													
211122	SF 32-51																																																																													
212122	SF 63-81																																																																													
198122	AF 67																																																																													
<table border="1"> <thead> <tr> <th>Art.-Nr.</th> <th>Typ</th> </tr> </thead> <tbody> <tr><td>141120</td><td>ZWM 1009</td></tr> <tr><td>142120</td><td>ZWM 1010</td></tr> <tr><td>141122</td><td>ZWM 2011</td></tr> <tr><td>142122</td><td>ZWM 2011-8</td></tr> <tr><td>143122</td><td>ZWM 2012</td></tr> <tr><td>144122</td><td>ZWM 2013</td></tr> <tr><td>143120</td><td>ZWM 1110</td></tr> <tr><td>145122</td><td>ZWM 2111</td></tr> <tr><td>146122</td><td>ZWM 2112</td></tr> <tr><td>147122</td><td>ZWM 2113</td></tr> <tr><td colspan="2"> </td></tr> <tr><td>141121</td><td>WTM 1001</td></tr> <tr><td>141123</td><td>WTM 2201</td></tr> <tr><td>142123</td><td>WTM 2202</td></tr> <tr><td>143123</td><td>WTM 2203</td></tr> </tbody> </table>	Art.-Nr.	Typ	141120	ZWM 1009	142120	ZWM 1010	141122	ZWM 2011	142122	ZWM 2011-8	143122	ZWM 2012	144122	ZWM 2013	143120	ZWM 1110	145122	ZWM 2111	146122	ZWM 2112	147122	ZWM 2113			141121	WTM 1001	141123	WTM 2201	142123	WTM 2202	143123	WTM 2203	<table border="1"> <thead> <tr> <th>Art.-Nr.</th> <th>Typ</th> </tr> </thead> <tbody> <tr><td>155122</td><td>ZWM 2301 ø40,00</td></tr> <tr><td>156122</td><td>ZWM 2302 ø50,00</td></tr> <tr><td>157122</td><td>ZWM 2303 ø60,00</td></tr> <tr><td>158122</td><td>ZWM 2304 ø50,80</td></tr> <tr><td colspan="2"> </td></tr> <tr><td>146123</td><td>WTM 2300 ø12</td></tr> <tr><td>147123</td><td>WTM 2301 ø16</td></tr> <tr><td>148123</td><td>WTM 2302 ø20</td></tr> <tr><td>149123</td><td>WTM 2303 ø25</td></tr> <tr><td>150123</td><td>WTM 2304 ø30</td></tr> <tr><td>151123</td><td>WTM 2305 ø32</td></tr> </tbody> </table>	Art.-Nr.	Typ	155122	ZWM 2301 ø40,00	156122	ZWM 2302 ø50,00	157122	ZWM 2303 ø60,00	158122	ZWM 2304 ø50,80			146123	WTM 2300 ø12	147123	WTM 2301 ø16	148123	WTM 2302 ø20	149123	WTM 2303 ø25	150123	WTM 2304 ø30	151123	WTM 2305 ø32	<p>Grundwerkzeughalter für Seitenschlitten Gildemeister Nutenstein starr und schwenkbar</p> 																				
Art.-Nr.	Typ																																																																													
141120	ZWM 1009																																																																													
142120	ZWM 1010																																																																													
141122	ZWM 2011																																																																													
142122	ZWM 2011-8																																																																													
143122	ZWM 2012																																																																													
144122	ZWM 2013																																																																													
143120	ZWM 1110																																																																													
145122	ZWM 2111																																																																													
146122	ZWM 2112																																																																													
147122	ZWM 2113																																																																													
141121	WTM 1001																																																																													
141123	WTM 2201																																																																													
142123	WTM 2202																																																																													
143123	WTM 2203																																																																													
Art.-Nr.	Typ																																																																													
155122	ZWM 2301 ø40,00																																																																													
156122	ZWM 2302 ø50,00																																																																													
157122	ZWM 2303 ø60,00																																																																													
158122	ZWM 2304 ø50,80																																																																													
146123	WTM 2300 ø12																																																																													
147123	WTM 2301 ø16																																																																													
148123	WTM 2302 ø20																																																																													
149123	WTM 2303 ø25																																																																													
150123	WTM 2304 ø30																																																																													
151123	WTM 2305 ø32																																																																													
 <table border="1"> <thead> <tr> <th>Art.-Nr.</th> <th>Typ</th> </tr> </thead> <tbody> <tr><td>215122</td><td>ZWV 2915</td></tr> <tr><td>216122</td><td>ZWV 2916</td></tr> </tbody> </table>	Art.-Nr.	Typ	215122	ZWV 2915	216122	ZWV 2916	<p>Einstechschieber mit zylindrischer Aufnahme</p>  <table border="1"> <thead> <tr> <th>Art.-Nr.</th> <th>Typ</th> </tr> </thead> <tbody> <tr><td>149120</td><td>ZWV 1111</td></tr> <tr><td>204122</td><td>ZWV 2112</td></tr> <tr><td>205122</td><td>ZWV 2114</td></tr> </tbody> </table>	Art.-Nr.	Typ	149120	ZWV 1111	204122	ZWV 2112	205122	ZWV 2114	<table border="1"> <thead> <tr> <th>Art.-Nr.</th> <th>Typ</th> </tr> </thead> <tbody> <tr><td>160122</td><td>ZWM 2030</td></tr> <tr><td>161122</td><td>ZWM 2031</td></tr> <tr><td>178122</td><td>ZWM 2030-S</td></tr> <tr><td>248122</td><td>ZWM 2031-S</td></tr> <tr><td>141124</td><td>ZWM 3030</td></tr> <tr><td>142124</td><td>ZWM 3031</td></tr> <tr><td>143124</td><td>ZWM 3032</td></tr> <tr><td>155124</td><td>ZWM 3030-S</td></tr> <tr><td>166124</td><td>ZWM 3031-S</td></tr> <tr><td>162122</td><td>ZWM 2040</td></tr> <tr><td>163122</td><td>ZWM 2041</td></tr> <tr><td>182122</td><td>ZWM 2040-S</td></tr> <tr><td>249122</td><td>ZWM 2041-S</td></tr> <tr><td>159124</td><td>ZWM 3040</td></tr> <tr><td>101130</td><td>N 2030-16</td></tr> <tr><td>119130</td><td>N 2031-18</td></tr> <tr><td>123130</td><td>N 2041/2241-18</td></tr> <tr><td>121130</td><td>N 3030-18</td></tr> <tr><td>104130</td><td>N 3031-20</td></tr> <tr><td>105130</td><td>N 3032-22</td></tr> <tr><td>181130</td><td>NS 2030-16</td></tr> <tr><td>199130</td><td>NS 2031-18</td></tr> <tr><td>186130</td><td>NS 2040-16</td></tr> <tr><td>203130</td><td>NS 2041-18</td></tr> <tr><td>201130</td><td>NS 3030-18</td></tr> <tr><td>205130</td><td>NS 3040-18</td></tr> <tr><td>184130</td><td>NS 3031-20</td></tr> <tr><td>188130</td><td>NS 3041-20</td></tr> <tr><td>185130</td><td>NS 3032-22</td></tr> <tr><td>189130</td><td>NS 3042-22</td></tr> </tbody> </table>	Art.-Nr.	Typ	160122	ZWM 2030	161122	ZWM 2031	178122	ZWM 2030-S	248122	ZWM 2031-S	141124	ZWM 3030	142124	ZWM 3031	143124	ZWM 3032	155124	ZWM 3030-S	166124	ZWM 3031-S	162122	ZWM 2040	163122	ZWM 2041	182122	ZWM 2040-S	249122	ZWM 2041-S	159124	ZWM 3040	101130	N 2030-16	119130	N 2031-18	123130	N 2041/2241-18	121130	N 3030-18	104130	N 3031-20	105130	N 3032-22	181130	NS 2030-16	199130	NS 2031-18	186130	NS 2040-16	203130	NS 2041-18	201130	NS 3030-18	205130	NS 3040-18	184130	NS 3031-20	188130	NS 3041-20	185130	NS 3032-22	189130	NS 3042-22
Art.-Nr.	Typ																																																																													
215122	ZWV 2915																																																																													
216122	ZWV 2916																																																																													
Art.-Nr.	Typ																																																																													
149120	ZWV 1111																																																																													
204122	ZWV 2112																																																																													
205122	ZWV 2114																																																																													
Art.-Nr.	Typ																																																																													
160122	ZWM 2030																																																																													
161122	ZWM 2031																																																																													
178122	ZWM 2030-S																																																																													
248122	ZWM 2031-S																																																																													
141124	ZWM 3030																																																																													
142124	ZWM 3031																																																																													
143124	ZWM 3032																																																																													
155124	ZWM 3030-S																																																																													
166124	ZWM 3031-S																																																																													
162122	ZWM 2040																																																																													
163122	ZWM 2041																																																																													
182122	ZWM 2040-S																																																																													
249122	ZWM 2041-S																																																																													
159124	ZWM 3040																																																																													
101130	N 2030-16																																																																													
119130	N 2031-18																																																																													
123130	N 2041/2241-18																																																																													
121130	N 3030-18																																																																													
104130	N 3031-20																																																																													
105130	N 3032-22																																																																													
181130	NS 2030-16																																																																													
199130	NS 2031-18																																																																													
186130	NS 2040-16																																																																													
203130	NS 2041-18																																																																													
201130	NS 3030-18																																																																													
205130	NS 3040-18																																																																													
184130	NS 3031-20																																																																													
188130	NS 3041-20																																																																													
185130	NS 3032-22																																																																													
189130	NS 3042-22																																																																													

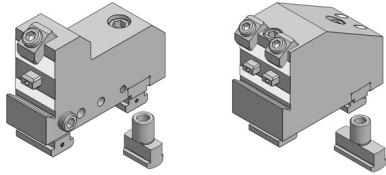
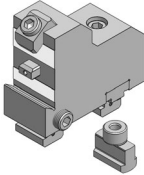
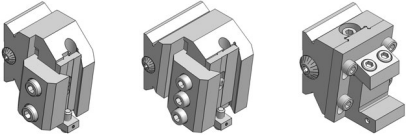
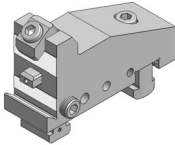
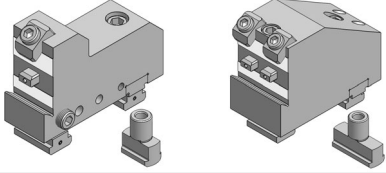
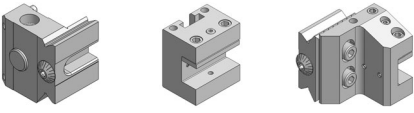
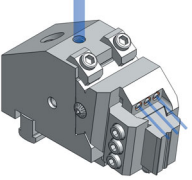
<p>Grundwerkzeughalter für Seitenschlitten Pittler - Nutenstein starr und schwenkbar</p> 	<p>Grundwerkzeughalter für Seitenschlitten ZPS SAY incl. schwenkbarem Nutenstein</p> 	<p>Werkzeugträger für Flachformmeissel</p> 																																																																																																																																		
<table border="1"> <thead> <tr> <th>Art.-Nr.</th> <th>Typ</th> </tr> </thead> <tbody> <tr><td>164122</td><td>ZWM 2130</td></tr> <tr><td>165122</td><td>ZWM 2131</td></tr> <tr><td>146124</td><td>ZWM 3130</td></tr> <tr><td>147124</td><td>ZWM 3131</td></tr> <tr><td>148124</td><td>ZWM 3132</td></tr> <tr><td>157124</td><td>ZWM 3130-S</td></tr> <tr><td>166122</td><td>ZWM 2140</td></tr> <tr><td>167122</td><td>ZWM 2141</td></tr> <tr><td>161124</td><td>ZWM 3140</td></tr> <tr><td>149124</td><td>ZWM 3141</td></tr> <tr><td>150124</td><td>ZWM 3142</td></tr> <tr><td colspan="2"> </td></tr> <tr><td>110130</td><td>N 2130-15,87</td></tr> <tr><td>111130</td><td>N 2131-19,05</td></tr> <tr><td>112130</td><td>N 3130-19,05</td></tr> <tr><td>114130</td><td>N 3132-22,22</td></tr> <tr><td>190130</td><td>NS 2130-15,87</td></tr> <tr><td>191130</td><td>NS 2131-19,05</td></tr> <tr><td>192130</td><td>NS 3130-19,05</td></tr> <tr><td>194130</td><td>NS 3132-22,22</td></tr> <tr><td>195130</td><td>NS 2140-15,87</td></tr> <tr><td>196130</td><td>NS 2141-19,05</td></tr> <tr><td>197130</td><td>NS 3141-19,05</td></tr> <tr><td>198130</td><td>NS 3142-22,22</td></tr> </tbody> </table>	Art.-Nr.	Typ	164122	ZWM 2130	165122	ZWM 2131	146124	ZWM 3130	147124	ZWM 3131	148124	ZWM 3132	157124	ZWM 3130-S	166122	ZWM 2140	167122	ZWM 2141	161124	ZWM 3140	149124	ZWM 3141	150124	ZWM 3142			110130	N 2130-15,87	111130	N 2131-19,05	112130	N 3130-19,05	114130	N 3132-22,22	190130	NS 2130-15,87	191130	NS 2131-19,05	192130	NS 3130-19,05	194130	NS 3132-22,22	195130	NS 2140-15,87	196130	NS 2141-19,05	197130	NS 3141-19,05	198130	NS 3142-22,22	<table border="1"> <thead> <tr> <th>Art.-Nr.</th> <th>Typ</th> </tr> </thead> <tbody> <tr><td>228122</td><td>SAY 32-6</td></tr> <tr><td>238122</td><td>SAY 32-6</td></tr> <tr><td>229122</td><td>SAY 32-6</td></tr> <tr><td>230122</td><td>SAY 32-6</td></tr> <tr><td>226122</td><td>SAY 40-6</td></tr> <tr><td>227122</td><td>SAY 40-6</td></tr> <tr><td>231122</td><td>SAY 40-6</td></tr> </tbody> </table> <p>Grundwerkzeughalter für Seitenschlitten INDEX MS25 incl. schwenkbarem Nutenstein</p>  <table border="1"> <thead> <tr> <th>Art.-Nr.</th> <th>Typ</th> </tr> </thead> <tbody> <tr><td>185122</td><td>ZWM 2310</td></tr> <tr><td>186122</td><td>ZWM 2311</td></tr> </tbody> </table>	Art.-Nr.	Typ	228122	SAY 32-6	238122	SAY 32-6	229122	SAY 32-6	230122	SAY 32-6	226122	SAY 40-6	227122	SAY 40-6	231122	SAY 40-6	Art.-Nr.	Typ	185122	ZWM 2310	186122	ZWM 2311	<table border="1"> <thead> <tr> <th>Art.-Nr.</th> <th>Typ</th> </tr> </thead> <tbody> <tr><td>161123</td><td>WTM 2050</td></tr> <tr><td>162123</td><td>WTM 2051</td></tr> <tr><td>163123</td><td>WTM 2051-S</td></tr> <tr><td>164123</td><td>WTM 2052</td></tr> <tr><td>145125</td><td>WTM 3050</td></tr> <tr><td>146125</td><td>WTM 3051</td></tr> <tr><td>147125</td><td>WTM 3051-S</td></tr> <tr><td>148125</td><td>WTM 3052</td></tr> <tr><td>149125</td><td>WTM 3052-S</td></tr> <tr><td>150125</td><td>WTM 3053</td></tr> <tr><td>165123</td><td>WTM 2060</td></tr> <tr><td>166123</td><td>WTM 2061</td></tr> <tr><td>167123</td><td>WTM 2061-S</td></tr> <tr><td>168123</td><td>WTM 2062</td></tr> <tr><td>151125</td><td>WTM 3060</td></tr> <tr><td>152125</td><td>WTM 3061</td></tr> <tr><td>153125</td><td>WTM 3061-S</td></tr> <tr><td>154125</td><td>WTM 3062</td></tr> <tr><td>155125</td><td>WTM 3062-S</td></tr> <tr><td>156125</td><td>WTM 3063</td></tr> <tr><td colspan="2"> </td></tr> <tr><td>155123</td><td>WTM 2071</td></tr> <tr><td>156123</td><td>WTM 2072</td></tr> </tbody> </table>	Art.-Nr.	Typ	161123	WTM 2050	162123	WTM 2051	163123	WTM 2051-S	164123	WTM 2052	145125	WTM 3050	146125	WTM 3051	147125	WTM 3051-S	148125	WTM 3052	149125	WTM 3052-S	150125	WTM 3053	165123	WTM 2060	166123	WTM 2061	167123	WTM 2061-S	168123	WTM 2062	151125	WTM 3060	152125	WTM 3061	153125	WTM 3061-S	154125	WTM 3062	155125	WTM 3062-S	156125	WTM 3063			155123	WTM 2071	156123	WTM 2072										
Art.-Nr.	Typ																																																																																																																																			
164122	ZWM 2130																																																																																																																																			
165122	ZWM 2131																																																																																																																																			
146124	ZWM 3130																																																																																																																																			
147124	ZWM 3131																																																																																																																																			
148124	ZWM 3132																																																																																																																																			
157124	ZWM 3130-S																																																																																																																																			
166122	ZWM 2140																																																																																																																																			
167122	ZWM 2141																																																																																																																																			
161124	ZWM 3140																																																																																																																																			
149124	ZWM 3141																																																																																																																																			
150124	ZWM 3142																																																																																																																																			
110130	N 2130-15,87																																																																																																																																			
111130	N 2131-19,05																																																																																																																																			
112130	N 3130-19,05																																																																																																																																			
114130	N 3132-22,22																																																																																																																																			
190130	NS 2130-15,87																																																																																																																																			
191130	NS 2131-19,05																																																																																																																																			
192130	NS 3130-19,05																																																																																																																																			
194130	NS 3132-22,22																																																																																																																																			
195130	NS 2140-15,87																																																																																																																																			
196130	NS 2141-19,05																																																																																																																																			
197130	NS 3141-19,05																																																																																																																																			
198130	NS 3142-22,22																																																																																																																																			
Art.-Nr.	Typ																																																																																																																																			
228122	SAY 32-6																																																																																																																																			
238122	SAY 32-6																																																																																																																																			
229122	SAY 32-6																																																																																																																																			
230122	SAY 32-6																																																																																																																																			
226122	SAY 40-6																																																																																																																																			
227122	SAY 40-6																																																																																																																																			
231122	SAY 40-6																																																																																																																																			
Art.-Nr.	Typ																																																																																																																																			
185122	ZWM 2310																																																																																																																																			
186122	ZWM 2311																																																																																																																																			
Art.-Nr.	Typ																																																																																																																																			
161123	WTM 2050																																																																																																																																			
162123	WTM 2051																																																																																																																																			
163123	WTM 2051-S																																																																																																																																			
164123	WTM 2052																																																																																																																																			
145125	WTM 3050																																																																																																																																			
146125	WTM 3051																																																																																																																																			
147125	WTM 3051-S																																																																																																																																			
148125	WTM 3052																																																																																																																																			
149125	WTM 3052-S																																																																																																																																			
150125	WTM 3053																																																																																																																																			
165123	WTM 2060																																																																																																																																			
166123	WTM 2061																																																																																																																																			
167123	WTM 2061-S																																																																																																																																			
168123	WTM 2062																																																																																																																																			
151125	WTM 3060																																																																																																																																			
152125	WTM 3061																																																																																																																																			
153125	WTM 3061-S																																																																																																																																			
154125	WTM 3062																																																																																																																																			
155125	WTM 3062-S																																																																																																																																			
156125	WTM 3063																																																																																																																																			
155123	WTM 2071																																																																																																																																			
156123	WTM 2072																																																																																																																																			
<p>Grundwerkzeughalter für Seitenschlitten Schütte - Nutenstein starr und schwenkbar</p>  <table border="1"> <thead> <tr> <th>Art.-Nr.</th> <th>Typ</th> </tr> </thead> <tbody> <tr><td>168122</td><td>ZWM 2230</td></tr> <tr><td>169122</td><td>ZWM 2231</td></tr> <tr><td>151124</td><td>ZWM 3230</td></tr> <tr><td>152124</td><td>ZWM 3231</td></tr> <tr><td>158124</td><td>ZWM 3230-S</td></tr> <tr><td>170122</td><td>ZWM 2240</td></tr> <tr><td>171122</td><td>ZWM 2241</td></tr> <tr><td>153124</td><td>ZWM 3240</td></tr> <tr><td>154124</td><td>ZWM 3241</td></tr> <tr><td colspan="2"> </td></tr> <tr><td>119130</td><td>N 2230/31-18</td></tr> <tr><td>123130</td><td>N 2041/2241-18</td></tr> <tr><td>121130</td><td>N 3230-18</td></tr> <tr><td>122130</td><td>N 3231-24</td></tr> <tr><td>199130</td><td>NS 2230/31-18</td></tr> <tr><td>201130</td><td>NS 3230-18</td></tr> <tr><td>203130</td><td>NS 2240/41-18</td></tr> <tr><td>205130</td><td>NS 3240-18</td></tr> <tr><td>206130</td><td>NS 3241-24</td></tr> </tbody> </table>	Art.-Nr.	Typ	168122	ZWM 2230	169122	ZWM 2231	151124	ZWM 3230	152124	ZWM 3231	158124	ZWM 3230-S	170122	ZWM 2240	171122	ZWM 2241	153124	ZWM 3240	154124	ZWM 3241			119130	N 2230/31-18	123130	N 2041/2241-18	121130	N 3230-18	122130	N 3231-24	199130	NS 2230/31-18	201130	NS 3230-18	203130	NS 2240/41-18	205130	NS 3240-18	206130	NS 3241-24	<p>Werkzeugträger, Werkzeugträgerrohlinge und Wechselhalter</p>  <table border="1"> <thead> <tr> <th>Art.-Nr.</th> <th>Typ</th> </tr> </thead> <tbody> <tr><td>112123</td><td>WT 2030</td></tr> <tr><td>113123</td><td>WT 2035</td></tr> <tr><td>101125</td><td>WT 3030</td></tr> <tr><td>102125</td><td>WT 3031</td></tr> <tr><td>103125</td><td>WT 3032</td></tr> <tr><td>104125</td><td>WT 3035</td></tr> <tr><td>105125</td><td>WT 3036</td></tr> <tr><td>106125</td><td>WT 3037</td></tr> <tr><td>116123</td><td>WT 2050</td></tr> <tr><td>117123</td><td>WT 2051</td></tr> <tr><td>109125</td><td>WT 3050</td></tr> <tr><td>110125</td><td>WT 3051</td></tr> <tr><td>118123</td><td>WH 2050</td></tr> <tr><td>119123</td><td>WH 2051</td></tr> <tr><td>111125</td><td>WH 3050</td></tr> <tr><td>123123</td><td>WH 2053</td></tr> <tr><td>123125</td><td>WH 3053</td></tr> <tr><td>135123</td><td>WH 2055</td></tr> <tr><td>136123</td><td>WH 2056</td></tr> <tr><td>126125</td><td>WH 3055</td></tr> <tr><td colspan="2"> </td></tr> <tr><td>115121</td><td>WT 1040-R</td></tr> <tr><td>114123</td><td>WT 2040-R</td></tr> <tr><td>115123</td><td>WT 2041-R</td></tr> <tr><td>107125</td><td>WT 3040-R</td></tr> <tr><td>108125</td><td>WT 3041-R</td></tr> <tr><td colspan="2"> </td></tr> <tr><td>140123</td><td>WT 2928</td></tr> </tbody> </table>	Art.-Nr.	Typ	112123	WT 2030	113123	WT 2035	101125	WT 3030	102125	WT 3031	103125	WT 3032	104125	WT 3035	105125	WT 3036	106125	WT 3037	116123	WT 2050	117123	WT 2051	109125	WT 3050	110125	WT 3051	118123	WH 2050	119123	WH 2051	111125	WH 3050	123123	WH 2053	123125	WH 3053	135123	WH 2055	136123	WH 2056	126125	WH 3055			115121	WT 1040-R	114123	WT 2040-R	115123	WT 2041-R	107125	WT 3040-R	108125	WT 3041-R			140123	WT 2928	<p>Grundwerkzeughalter und Werkzeugträger mit i.K. für Schütte incl. schwenkbarem Nutenstein</p>  <table border="1"> <thead> <tr> <th>Art.-Nr.</th> <th>Typ</th> </tr> </thead> <tbody> <tr><td>250122</td><td>ZWM 2240 ik</td></tr> <tr><td>246122</td><td>ZWM 2241 ik</td></tr> <tr><td>182124</td><td>ZWM 3240 ik</td></tr> <tr><td>183124</td><td>ZWM 3241 ik</td></tr> <tr><td>184124</td><td>ZWM 3230 ik</td></tr> <tr><td>185124</td><td>ZWM 3231 ik</td></tr> <tr><td colspan="2"> </td></tr> <tr><td>306123</td><td>WTM 2052 ik</td></tr> <tr><td>238125</td><td>WTM 3052-S ik</td></tr> <tr><td>176125</td><td>WTM 3061 ik</td></tr> <tr><td>240125</td><td>WTM 3061 ik</td></tr> <tr><td>239125</td><td>WTM 3062 ik</td></tr> <tr><td>241125</td><td>WTM 3062 ik</td></tr> <tr><td>237125</td><td>WTM 3062-S ik</td></tr> <tr><td>242125</td><td>WTM 3063 ik</td></tr> </tbody> </table>	Art.-Nr.	Typ	250122	ZWM 2240 ik	246122	ZWM 2241 ik	182124	ZWM 3240 ik	183124	ZWM 3241 ik	184124	ZWM 3230 ik	185124	ZWM 3231 ik			306123	WTM 2052 ik	238125	WTM 3052-S ik	176125	WTM 3061 ik	240125	WTM 3061 ik	239125	WTM 3062 ik	241125	WTM 3062 ik	237125	WTM 3062-S ik	242125	WTM 3063 ik
Art.-Nr.	Typ																																																																																																																																			
168122	ZWM 2230																																																																																																																																			
169122	ZWM 2231																																																																																																																																			
151124	ZWM 3230																																																																																																																																			
152124	ZWM 3231																																																																																																																																			
158124	ZWM 3230-S																																																																																																																																			
170122	ZWM 2240																																																																																																																																			
171122	ZWM 2241																																																																																																																																			
153124	ZWM 3240																																																																																																																																			
154124	ZWM 3241																																																																																																																																			
119130	N 2230/31-18																																																																																																																																			
123130	N 2041/2241-18																																																																																																																																			
121130	N 3230-18																																																																																																																																			
122130	N 3231-24																																																																																																																																			
199130	NS 2230/31-18																																																																																																																																			
201130	NS 3230-18																																																																																																																																			
203130	NS 2240/41-18																																																																																																																																			
205130	NS 3240-18																																																																																																																																			
206130	NS 3241-24																																																																																																																																			
Art.-Nr.	Typ																																																																																																																																			
112123	WT 2030																																																																																																																																			
113123	WT 2035																																																																																																																																			
101125	WT 3030																																																																																																																																			
102125	WT 3031																																																																																																																																			
103125	WT 3032																																																																																																																																			
104125	WT 3035																																																																																																																																			
105125	WT 3036																																																																																																																																			
106125	WT 3037																																																																																																																																			
116123	WT 2050																																																																																																																																			
117123	WT 2051																																																																																																																																			
109125	WT 3050																																																																																																																																			
110125	WT 3051																																																																																																																																			
118123	WH 2050																																																																																																																																			
119123	WH 2051																																																																																																																																			
111125	WH 3050																																																																																																																																			
123123	WH 2053																																																																																																																																			
123125	WH 3053																																																																																																																																			
135123	WH 2055																																																																																																																																			
136123	WH 2056																																																																																																																																			
126125	WH 3055																																																																																																																																			
115121	WT 1040-R																																																																																																																																			
114123	WT 2040-R																																																																																																																																			
115123	WT 2041-R																																																																																																																																			
107125	WT 3040-R																																																																																																																																			
108125	WT 3041-R																																																																																																																																			
140123	WT 2928																																																																																																																																			
Art.-Nr.	Typ																																																																																																																																			
250122	ZWM 2240 ik																																																																																																																																			
246122	ZWM 2241 ik																																																																																																																																			
182124	ZWM 3240 ik																																																																																																																																			
183124	ZWM 3241 ik																																																																																																																																			
184124	ZWM 3230 ik																																																																																																																																			
185124	ZWM 3231 ik																																																																																																																																			
306123	WTM 2052 ik																																																																																																																																			
238125	WTM 3052-S ik																																																																																																																																			
176125	WTM 3061 ik																																																																																																																																			
240125	WTM 3061 ik																																																																																																																																			
239125	WTM 3062 ik																																																																																																																																			
241125	WTM 3062 ik																																																																																																																																			
237125	WTM 3062-S ik																																																																																																																																			
242125	WTM 3063 ik																																																																																																																																			

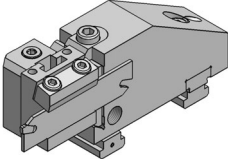
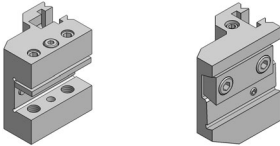
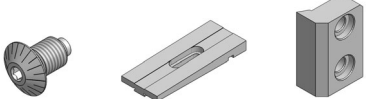
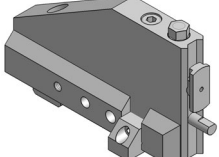
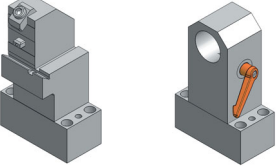
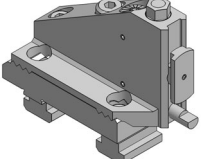
Grundwerkzeughalter und Werkzeugträger zum Abstecken für Gildemeister + Schütte		Wechselhalter schmale Ausführung		Ersatzteile			
							
Art.-Nr.	Typ	Art.-Nr.	Typ	Art.-Nr.	Typ		
187122	ZWM 2031-A	101129	WH 1050	192101	P 1000		
163124	ZWM 3031-A	102129	WH 1051	193101	P 2000		
164124	ZWM 3032-A	103129	WH 1016-R0°	194101	P 2001		
188122	ZWM 2231-A	104129	WH 1016-L0°	195101	P 3000		
165124	ZWM 3231-A	105129	WH 1017-R	196101	SP 2000		
157123	WTM 2050-A	106129	WH 1017-L	197101	SP 3000		
158123	WTM 2051-A	107129	WH 1026-R	198101	EX 2000		
141125	WTM 3050-A	108129	WH 1026-L	199101	EX 3000		
142125	WTM 3051-A	109129	WH 1020 RA	200101	AN 10		
Grundwerkzeughalter für Seitenschlitten schmale Ausführung 		110129	WH 1016 RA	201101	AN 20		
		111129	WH 1020 RA	130100	FS 10		
		113129	WH 1020 LA	133100	FS 20		
		114129	WH 1016 LA	136100	Anschlag ø6		
		115129	WH 1020 LA	202101	EP 14		
		117129	WH 1020-R	203101	EP 13		
		118129	WH 1020-L	204101	EP 20		
		119129	WH 1020-R	205101	P 2050		
		120129	WH 1020-L	206101	P 2051		
		121129	WH 1026 RA	207101	P 2052		
		122129	WH 1026 LA	208101	P 3050		
		123129	WH 1017 RA	209101	P 3051		
		124129	WH 1017 LA	210101	P 3051-S		
		Adapter für Voreinstellung 		211101	P 3052	211101	P 3052
				212129	WH 1020 RA	212101	P 3052-S
213129	WH 1020 LA			213101	P 3053		
214129	WH 1016 LA			214101	P 2060		
215129	WH 1020-R			215101	P 2061		
216129	WH 1020-L			216101	P 2062		
217129	WH 1026 RA			217101	P 3060		
218129	WH 1026 LA			218101	P 3061		
219129	WH 1017 RA			219101	P 3061-S		
220129	WH 1017 LA			220101	P 3062		
221129	WH 1016 RA			221101	P 3062-S		
222129	WH 1016 LA			222101	P 3063		
223129	WH 1020-R			223101	VK 2020		
224129	WH 1020-L			224101	VK 2028		
225129	WH 1026 RA			225101	VK 2040		
226129	WH 1026 LA	226101	VK 3020				
227129	WH 1017 RA	227101	VK 3028				
228129	WH 1017 LA	228101	VK 3040				
229129	WH 1016 RA	229101	VK 3050				
230129	WH 1016 LA	230101	AN20/30				
231129	WH 1020-R	231101	SP 101				
232129	WH 1020-L	232101	EX 101				
171100	Schraube	171100	Schraube				
Grundwerkzeughalter für Seitenschlitten mit Maßkorrektur ± 0,25 		250130	AZWM 1000-1				
		251130	AZWM 1000-2				
		252130	AZWM 2000-1				
		253130	AZWM 2000-2				
		254130	AZWM 3000-1				
255130	AZWM 3000-2						
282130	AZWM 101-1						
283130	AZWM 101-2						
		256130	AZWM 7040-1				
		257130	AZWM 7040-2				
		258130	AZWM 7050-1				
		259130	AZWM 7050-2				
		297130	ø28x172				
298130	ø36x172						
301130	ø28+1"x172						
303130	Sph.140						
304130	Sph.172						